

The contents of this publication are the copyright of the publisher and may not be reproduced (even extracts) unless prior written permission is granted. Every care has been taken to ensure the accuracy of the information contained in this publication but no liability can be accepted for any loss or damage whether direct, indirect or consequential arising out of the use of the information contained herein.

Le contenu de cette publication est soumis au copyright de l'éditeur et sa reproduction, même partielle, est interdite sans autorisation écrite préalable. Le plus grand soin a été apporté à l'exactitude des informations données dans cette publication mais SKF décline toute responsabilité pour les pertes ou dommages directs ou indirects découlant de l'utilisation du contenu du présent document.

Nachdruck, auch auszugsweise, nur mit unserer vorherigen schriftlichen Genehmigung gestattet. Die Angaben in dieser Druckschrift wurden mit größter Sorgfalt auf ihre Richtigkeit hin überprüft. Trotzdem kann keine Haftung für Verluste oder Schäden irgendwelcher Art übernommen werden, die sich mittelbar oder unmittelbar aus der Verwendung der hier enthaltenen Informationen ergeben.

El contenido de esta publicación es propiedad de los editores y no puede reproducirse (incluso parcialmente) sin autorización previa por escrito. Se ha tenido el máximo cuidado para garantizar la exactitud de la información contenida en esta publicación, pero no se acepta ninguna responsabilidad por pérdidas o daños, ya sean directos, indirectos o consecuentes, que se produzcan como resultado del uso de dicha información.

La riproduzione, anche parziale, del contenuto di questa pubblicazione è consentita soltanto previa autorizzazione scritta della SKF. Nella stesura è stata dedicata la massima attenzione al fine di assicurare l'accuratezza dei dati, tuttavia non si possono accettare responsabilità per eventuali errori od omissioni, nonché per danni o perdite diretti o indiretti derivanti dall'uso delle informazioni qui contenute.

O conteúdo desta publicação é de direito autoral do editor e não pode ser reproduzido (nem mesmo parcialmente), a não ser com permissão prévia por escrito. Todo cuidado foi tomado para assegurar a precisão das informações contidas nesta publicação, mas nenhuma responsabilidade pode ser aceita por qualquer perda ou dano, seja direto, indireto ou consequente, como resultado do uso das informações aqui contidas.

本出版物内容的著作权归出版者所有且未经事先书面许可不得被复制（甚至引用）。我们已采取了一切注意措施以确定本出版物包含的信息准确无误，但我们不对因使用此等信息而产生的任何损失或损害承担任何责任，不论此等责任是直接、间接或附随性的。

Содержание этой публикации является собственностью издателя и не может быть воспроизведено (даже частично) без предварительного письменного разрешения. Несмотря на то, что были приняты все меры по обеспечению точности информации, содержащейся в настоящем издании, издатель не несет ответственности за любой ущерб, прямой или косвенный, вытекающий из использования вышеуказанной информации.



SKF Maintenance Products

© SKF is a registered trademark of the SKF Group.
© SKF Group 2015/03

www.mapro.skf.com
www.skf.com/mount

MP5446

SKF



SKF TMFT 24

Instructions for use
Mode d'emploi
Bedienungsanleitung
Instrucciones de uso

Manuale d'istruzioni
Instruções de uso
使用说明书
Инструкция по эксплуатации





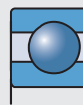
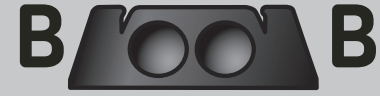
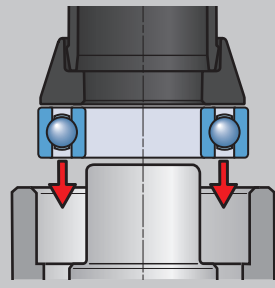

TMBA G11W
MP5446

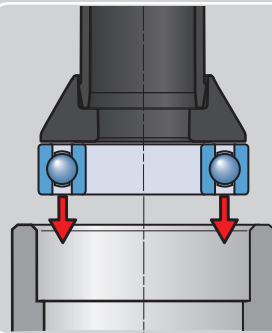
<p>4,5,6</p>	<p>7,8</p>	<p>7,8</p>









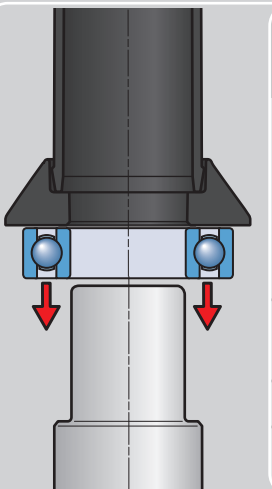

	10-26	10-30	10-35	12-28	12-32	12-37	15-32	15-35	15-42	17-35	17-40	17-47	20-42	20-47	20-52	25-47	25-52	25-62	30-55	30-62	30-72	35-62	35-72	35-80	40-68	40-80	40-90	45-75	45-85	45-100	50-80	50-90	50-110	55-90	55-100	55-120		
60..	6000			6001			6002			6003			6004*			6005			6006			6007			6008			6009			6010			6011				
62..	629	6200			6201			6202		6203				6204		62/22	6205		62/28	6206			6207			6208			6209			6210			6211			
63..			6300		6301			6302		6303				6304		63/22	6305		63/28	6306			6307				6308			6309			6310				6311	
64..																6403			6404				6405				6406			6407			6408				6409	
160..							16002			16003			16004*			16005			16006			16007			16008			16009			16010			16011				
161..	16100			16101									98204*			98205			98206																			
982..										98203			98204*			98205			98206																			
63... 62...	63000	62200	62300	63001	62201	62301	63002	62202	62302	63003	62203	62303	63004*	62204	62304	63005	62205	62305	63006	62206	62306	63007	62207	62307	63008	62208	62308	63009	62209	62309	63010	62210	62310		62211	62311		
2.. 3..																		305	206	306		207	307		208	308		209	309		210	310		211	311			
361...		361200			361201			361202			361203			361204			361205			361206			361207															
70..	7000			7001			7002			7003			7004*		7005			7006		7007					7008			7009			7010			7011				
72.. 73..		7200			7201	7301		7202	7302		7203	7303		7204	7304		7205	7305		7206	7306		7207	7307		7208	7308		7209	7309		7210	7310		7211	7311		
QJ..								QJ202		QJ203	QJ303			QJ304	QJ205	QJ305		QJ206	QJ306		QJ207	QJ307			QJ208	QJ308			QJ309		QJ210			QJ211	QJ311			
42.. 43..		4200			4201	4301		4202	4302		4203	4303		4204	4304		4205	4305		4206	4306		4207	4307		4208	4308		4209	4309		4210	4310		4211	4311		
32.. 33..		3200			3201			3202	3302		3203	3303		3204	3304		3205	3305		3206	3306		3207	3307		3208	3308		3209	3309		3210	3310		3211	3311		
12..	129	1200			1201			1202		1203			1204		1205			1206		1207					1208			1209			1210			1211				
22..		2200			2201			2202		2203			2204		2205			2206		2207					2208			2209			2210			2211				
13..						1301		1302		1303			1304		1305			1306		1307			1308			1309			1310			1311						
23..					2301			2303		2303			2304		2305			2306		2307			2308			2309			2310			2311						
213.. 223..																	21305		21306			21307				21308			21309			21310			21311			
222..														22205/20	22205			22206			22207					22208	22209		22210	22211		22212	22213		22214	22215		
N 10.. N 2..							N 202			N 203			N 204	N 1005	N 205		N 1006	N 206		N 1007	N 207			N 1008	N 208		N 1009	N 209		N 1010	N 210		N 1011	N 211				
N 3.. N 30..											N 303	N 3004*	N 304	N 3005		N 305	N 3006		N 306	N 3007			N 307	N 3008		N 308	N 3009		N 309	N 3010		N 310	N 3011		N 311			
N 22.. N 23..										N 2203		N 2204	N 2304		N 2205	N 2305		N 2206	N 2306		N 2207	N 2307			N 2208	N 2308		N 2209	N 2309		N 2210	N 2310		N 2211	N 2311			
302.. 303..								30302		30203	30303		30204	30304		30205	30305		30206	30306		30207	30307		30208	30308		30209	30309		30210	30310		30211	30311			
313.. 320..												32004*		32005		31305	32006		31306	32007			31307	32008		31308	32009		31309	32010		31310	32011		31311			
322.. 323..											32303		32304		32205	32305		32206	32306		32207	32307			32208	32308		32209	32309		32210	32310		32211	32311			
330.. 332..															33205			33206			33207				33208			33209		33010	33210		33011	33211				
CARB®																C 2205		C 6006	C 2206			C 2207			C 2208			C 2209		C 4010	C 2210			C 2211				



	A 										B 					C 				
	A10-26	A10-30	A12-28	A12-37	A15-32	B20-42	B25-47	B25-52	B30-55	B35-62	B35-72	C40-68	C40-90	C45-C85	C45-100	C50-80	C50-110			
	618.	61803		61805	61804	61806	61807	61808	61809	61810	61811									
	619..		61903	61902	61904	61905	61906		61907	61908	61910	61909				61911				
	NU 4..											NU406		NU407		NU408	NU409			
	NJ 4..											NJ406		NJ407		NJ408	NJ409			
	CARB®													C4908V	C4910V					
												C6910V	C6909V	C6912V		C6911V				



	A 				B 				C 				
	A10-26	A12-28	A15-32	A17-35	B20-42	B25-47	B30-55	B35-62	C40-68	C45-75	C50-80	C55-90	
60..					6004								
160..				16004									
982..				98204									
	618..	61800	61801	61802	61803	61804	61805	61806	61807	61808	61809	61810	61811
	619..	61900	61901	61902	61903	61904	61905	61906	61907	61908	61909	61910	61911
	63...				63004								
	NU 4..									NU406	NU407	NU408	NU409
	NJ 4..									NJ406	NJ407	NJ408	NJ409
	32...				32004								
	CARB®									C4908		C4910	C6910
												C6910	

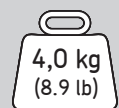

TMFT 24

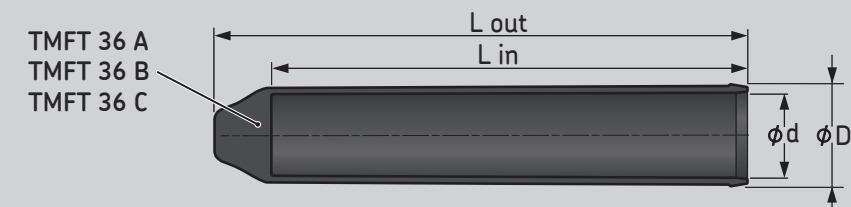
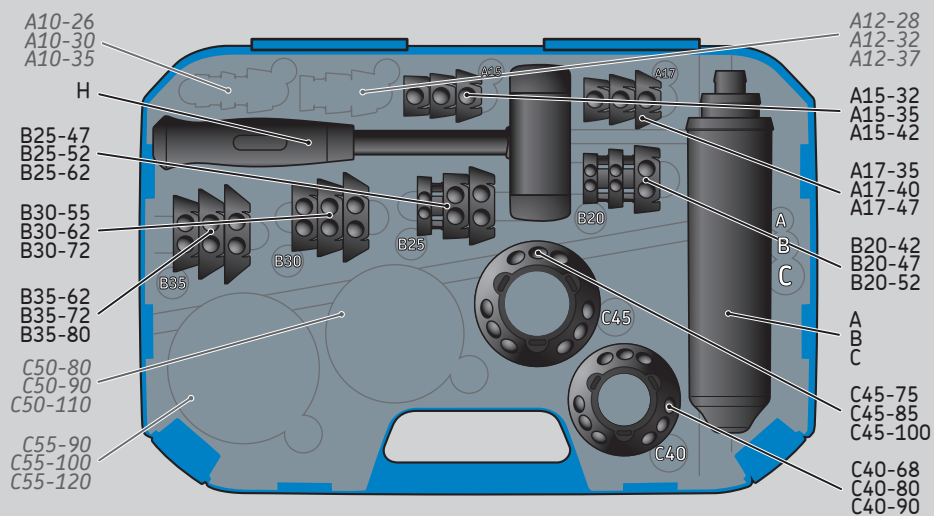
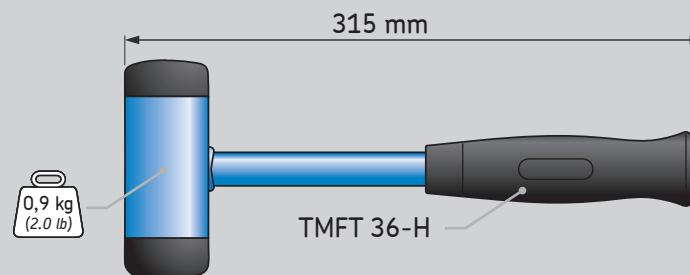
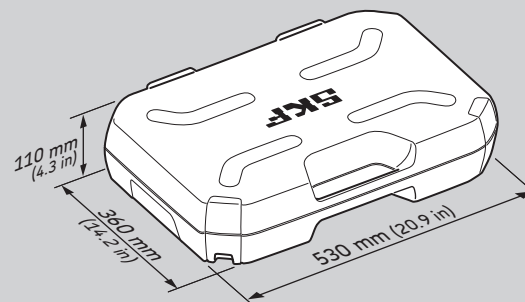

	D		d		L out		L in	
	mm	in	mm	in	mm	in	mm	in
TMFT 36 A	25	1.0	18	0.7	228	9.0	210	8.3
TMFT 36 B	45	1.7	37	1.4	235	9.3	210	8.3
TMFT 36 C	66	2.6	57	2.2	245	9.6	215	8.4

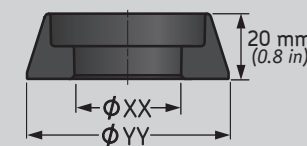

TMFT 36 C45-100 = TMFT 36 C45-10
 TMFT 36 C50-110 = TMFT 36 C50-11
 TMFT 36 C55-100 = TMFT 36 C55-10
 TMFT 36 C55-120 = TMFT 36 C55-12

TMFT 36 ..	TMFT 36 ..	TMFT 36 ..	TMFT 36 ..	TMFT 36 ..	TMFT 36 ..
A10-26	A15-32	B20-42	B30-55	C40-68	C50-80
A10-30	A15-35	B20-47	B30-62	C40-80	C50-90
A10-35	A15-42	B20-52	B30-72	C40-90	C50-110
A12-28	A17-35	B25-47	B35-62	C45-75	C55-90
A12-32	A17-40	B25-52	B35-72	C45-85	C55-100
A12-37	A17-47	B25-62	B35-80	C45-100	C55-120
A XX-YY		B XX-YY		C XX-YY	